

## MT290...SD08 Торцовые фрезы 90°

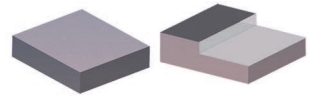

\* Особо эффективны в инструментальном производстве.









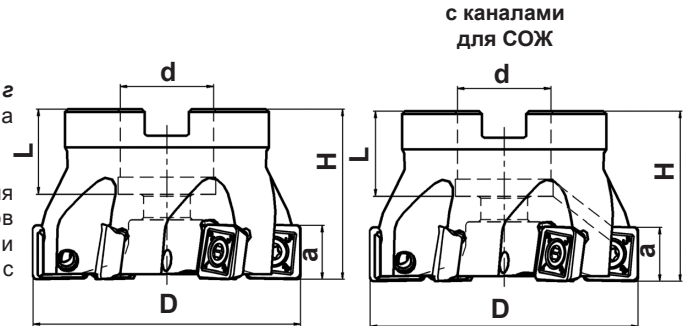







\* Четыре режущие кромки.

\* Низкие силы резания.

**Нормальный шаг** для обработки на малых фрезерных станках и обрабатывающих центрах.

**Мелкий шаг** для фрезерования плоскостей разъемов штампов и прессформ с тонкостенными секциями и обработки с малой глубиной резания.



Обозначение	Размеры, мм						n <sub>max</sub> RPM	 кг		Кол.			
	D	a	L	H	d	Z							
<b>Нормальный шаг</b>											<b>Глубина резания до 8 мм</b>		
MT290-050A22R06SD08	50	8	20	40	22	6	19500	0,3	SDMT08T308ER	6			
MT290-063A22R07SD08	63	8	20	40	22	7	17000	0,6		7			
MT290-080B27R09SD08	80	8	22	50	27	9	14500	1,4		9			
MT290-100B32R11SD08	100	8	25	50	32	11	12500	1,7		11			
MT290-125B40R14SD08	125	8	29	63	40	14	11000	2,6		14			
<b>Мелкий шаг</b>											<b>Глубина резания до 8 мм</b>		
MT290-050A22R07SD08	50	8	20	40	22	7	19500	0,3	SDMT08T308ER	7			
MT290-063A22R09SD08	63	8	20	40	22	9	17000	0,6		9			
MT290-080B27R11SD08	80	8	22	50	27	11	14500	1,4		11			
MT290-100B32R13SD08	100	8	25	50	32	13	12500	1,7		13			
MT290-125B40R15SD08	125	8	29	63	40	15	11000	2,6		15			
<b>Нормальный шаг</b>											<b>Глубина резания до 8 мм</b>		
MT290-050A22R06SD08-1K	50	8	20	40	22	6	19500	0,3	SDMT08T308ER	6			
MT290-063A22R07SD08-1K	63	8	20	40	22	7	17000	0,6		7			
MT290-080A27R09SD08-1K	80	8	22	50	27	9	14500	1,4		9			
MT290-100A32R11SD08-1K	100	8	25	50	32	11	12500	1,7		11			
MT290-125A40R14SD08-1K	125	8	29	63	40	14	11000	2,6		14			
<b>Мелкий шаг</b>											<b>Глубина резания до 8 мм</b>		
MT290-050A22R07SD08-1K	50	8	20	40	22	7	19500	0,3	SDMT08T308ER	7			
MT290-063A22R09SD08-1K	63	8	20	40	22	9	17000	0,6		9			
MT290-080A27R11SD08-1K	80	8	22	50	27	11	14500	1,4		11			
MT290-100A32R13SD08-1K	100	8	25	50	32	13	12500	1,7		13			
MT290-125A40R15SD08-1K	125	8	29	63	40	15	11000	2,6		15			

	Марка твердого сплава												Основные размеры							
	P			M			K			S			H			ic	l	S	d1	r
	HCP25X	HCP30X	HCM35X	HCM25X	HCM35X	HCS25X	HCP25X	HCP25X	HCP25X	HCS25X	HCS30X				мм					
	●	●	○	●	●	○	○	○	○	○	○				9,0	9,0	3,97	3,4	0,8	
SDMT08T308ER																				